AIRWORTHINESS DIRECTIVE

On the effective date specified below, and for the reasons set out in the background section, the CASA delegate whose signature appears below revokes Airworthiness Directive (AD) AD/BEECH 36/54 and issues the following AD under subregulation 39.001(1) of CASR 1998. The AD requires that the action set out in the requirement section (being action that the delegate considers necessary to correct the unsafe condition) be taken in relation to the aircraft or aeronautical product mentioned in the applicability section: (a) in the circumstances mentioned in the requirement section; and (b) in accordance with the instructions set out in the requirement section; and (c) at the time mentioned in the compliance section.

Beechcraft 36 (Bonanza) Series Aeroplanes

AD/BEECH 36/54
Amdt 1

Forward Elevator Cable

4/2012

Applicability: All Beechcraft 36 (Bonanza) aeroplanes fitted with the forward elevator control cable configuration as detailed in figure 1 of this AD.

Requirement:

1. Inspect the forward elevator control cable assembly for wear, broken wires and corrosion; or replace the forward elevator cable assembly.
2. Remove from service any forward elevator control cable assembly found to be defective as a result of inspection conducted in accordance with Requirement 1 of this AD.
3. Do not install on any aircraft a cable assembly or parts thereof that have been removed in accordance with Requirement 2 of this AD.

Note 1: Inspections carried out in accordance with FAA AC 43-13-1B, chapter 7, Section 8, paragraph 7-149(d) or Beechcraft maintenance data are an acceptable means of compliance for the inspection called up by Requirement 1 of this AD.

Compliance: For Requirement 1.

For those aircraft that have **not** had the forward elevator cable assembly replaced or inspected within the last maintenance release period - Remains unchanged as - Before further flight after the 16 January 2012 (the effective date of the original issue of this AD).

For those aircraft located where the inspection cannot be carried out - one positioning flight (pilot only) is allowed to a place where the inspection can be carried out.

Aircraft that have had the forward elevator cable assembly replaced or inspected in accordance with the original issue of this AD are considered to be in compliance with Requirement 1 of this AD.

Beechcraft 36 (Bonanza) Series Aeroplanes

AD/BEECH 36/54 Amdt 1 (continued)

For Requirement 2. Before further flight.

For Requirement 3. After the effective date of this AD.

This Amendment becomes effective on 27 February 2012.

Background: CASA has received a report describing a forward elevator cable failure (separation) immediately prior to take-off. The elevator remained firmly in the full 'down' position due to system spring tension.

A second aircraft was inspected at the owner's request immediately following the discovery of the failed cable. The forward elevator cable in this aircraft was found to be extensively frayed in the same location as the failed cable.

Since the original issue of this AD, CASA has received reports of 5 more cables found to be unserviceable.

This AD required immediate inspection of the forward elevator cable and replacement for elevator cables over 15 years old, and required continuing inspections of the entire elevator control system to preclude the unanticipated failure of the elevator flight control system which may result in loss of control of the aircraft.

Requirements for repeat inspections and the mandatory removal of cables in excess of 15 years in service have been removed from this AD following the publication of Instructions for Continuing Airworthiness (ICA) by the manufacturer. Those ICA are considered satisfactory to ensure the failure of the elevator cable does not occur provided that the ICA is adhered to during the inspection process.

This Amendment clarifies the applicability section of the AD by introducing additional criteria (Figure 1) to assist the registered operator in determining whether this AD is applicable to their aircraft.

The original issue of this AD became effective on 16 January 2012.

Beechcraft 36 (Bonanza) Series Aeroplanes

AD/BEECH 36/54 Amdt 1 (continued)

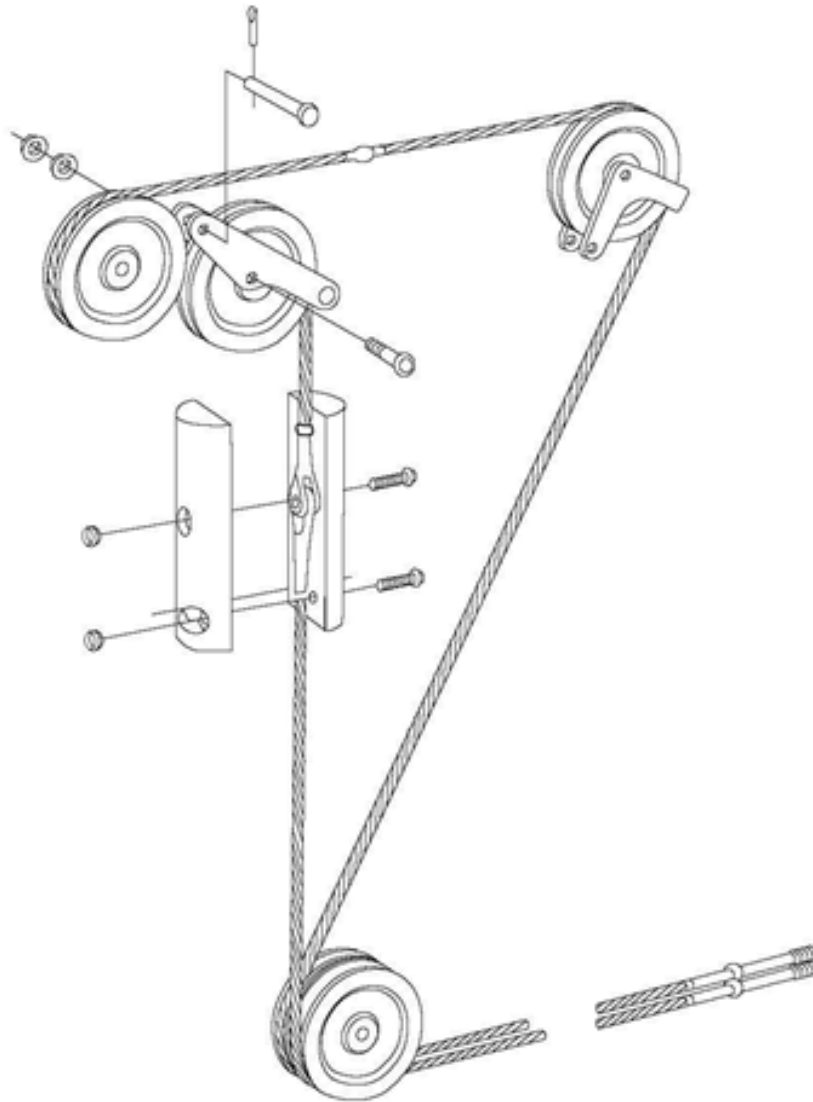

Figure 1 - Forward Elevator Control Cable - Adapted from Beechcraft Illustrated Parts Catalogue.

Peter Boyd
Delegate of the Civil Aviation Safety Authority

23 February 2012